



Optimax Pro Retrofit Instructions

99-18901-I002



Copyright © 2011 by

ALL rights reserved. Information in this document is subject to change without notice. Companies, names and data used in examples herein are fictitious unless otherwise noted. No part of this document may be reproduced or transmitted in any form or by any means, electronic or mechanical, for any purpose, without express permission of Anthony Manufacturing Co., Inc.

Anthony products identified in this manual are designed and certified to meet or ~~UL~~ for safety, and for sanitation standards.

European products meet ~~CE~~ requirements.

Each customer is responsible for final site approval.

TABLE OF CONTENTS

- 1. Preliminary Considerations for Optimax Pro LED Installation 4
 - 1.1. Warnings and Important Notes 4
 - 1.2. Safety 5
 - 1.3. Tools..... 5
 - 1.4. Tips..... 5
- 2. Parts List..... 6
 - 2.1. LED Power Supplies..... 6
 - 2.1.1. High Power..... 6
 - 2.1.2. Low Power 6
 - 2.2. Center and End Fixtures..... 7
- 3. Optional Wire Assembly..... 8
- 4. Removing Existing Lighting System..... 8
- 5. Locate, Drill and Mount the LED Fixture to the Mullion 9
- 6. Mounting the LED Power Supplies 12
 - 6.1. High Power and Low Power Driver Connections 12
- 7. Wiring Diagrams and Orientation 12
 - 7.1. Typical Configuration – One Door (07-18678-0001)..... 12
 - 7.2. Typical Configuration – Two Door (07-18678-0002)..... 13
 - 7.3. Typical Configuration – Three Door (07-18678-0003) 13
 - 7.4. Typical Configuration – Four Door (07-18678-0004) 14
 - 7.5. Typical Configuration – Five Door (07-18678-0005)..... 14
 - 7.6. Typical Configuration – Six Door (07-18678-0006)..... 15
 - 7.7. Typical Configuration – One Door (07-18679-0001)..... 15
 - 7.8. Typical Configuration – Two Door (07-18679-0002)..... 16
 - 7.9. Typical Configuration – Three Door (07-18679-0003) 16
 - 7.10. Typical Configuration – Four Door (07-18679-0004) 17
 - 7.11. Typical Configuration – Five Door (07-18679-0005)..... 17
 - 7.12. Typical Configuration – Six Door (07-18679-0006)..... 17
- 8. Revision History Page..... 18

1. Preliminary Considerations for Optimax Pro LED Installation

1.1. Warnings and Important Notes

All work performed must be done by a qualified electrician. Local and national electrical codes must be followed in the refurbishment of the lighting system.

Part numbers referenced in the following instructions can be purchased from Anthony Inc. Parts Department if they are not available at your location.



WARNING – Risk of fire or electric shock. Luminaires wiring or other electrical parts may be damaged when drilling for installation hardware. Check for enclosed wiring and components.



NOTE – Only those open holes indicated in the photographs and/or drawings may be made or altered as a result of kit installation. Do not leave any other open holes in an enclosure of wiring or electrical components.



WARNING – Risk of fire or electric shock. Install this kit only in the luminaires that has the construction features shown in the photographs and / or drawings.



WARNING – To prevent wiring damage or abrasion, do not expose wiring to edges of sheet metal or other sharp objects.



WARNING – Installation of this retrofit assembly requires a person familiar with the construction and operation of electrical systems and the hazards involved.



BEFORE YOU BEGIN

Read instructions completely and carefully.



WARNING – To reduce the risk of fire, electrical shock or injury, observe the following:

1. Use this unit in the manner intended by the manufacturer.
2. Before servicing or cleaning switch the power off.



WARNING – Turn power off before removing existing lighting system and follow appropriate lock out/tag out safety procedures



WARNING – For use inside a commercial refrigeration case with packaged foods only.

Note: Remove and dispose of existing ballasts per any local or Federal guidelines.

1.2. Safety

Proper safety equipment includes:



Safety Glasses



Work Gloves



Work Shoes



NOTE: Turn off all electrical power prior to beginning work on the door or on any electrical equipment. Use extra caution when working with or around the door glass package.

1.3. Tools

Tools required for this procedure include:

- #2 Phillips-head screwdriver
- Cordless drill w/attachments
- Needle-nose pliers
- Rubber or plastic mallet
- Flat-head screwdriver
- Wire stripper and cutter

1.4. Tips

- Complete replacement of wire assemblies is recommended whenever required. Splice wires only if necessary, using proper materials: such as electrical tape, wire nuts, flux core solder and heat shrink.
- Apply liquid soap to rail plastic covers and gaskets upon installation to facilitate insertion into mounting grooves.
- Keep doors and frames clean for product efficiency. This can also help reduce energy consumption and potential health hazards.
- Whenever binding gasket or plastic parts, use food grade silicone.
- Always use the correct tool for the job to be performed. This ensures proper installation and minimizes safety risks.

2. Parts List

2.1. LED Power Supplies

2.1.1. High Power

The high power power supply is 500 mA, 120 VAC only.



60-17544-0001

2.1.2. Low Power

The low power power supply is 350 mA, 100-240 VAC. The gray and violet wires need to be shorted together for 100% output.



60-18557-0001

2.2. Center and End Fixtures



Center Fixture (60-18184-0000)



End Fixture (60-18185-0000)

Optimax Pro LED Lighting		
Description	Center Fixture Part No.	Color Temp (K)
72" Light Fixture	60-18184-0102	4000
60" Light Fixture	60-18184-0001	4000
48" Light Fixture	60-18184-0003	4000
36" Light Fixture	60-18184-0004	4000
30" Light Fixture	60-18184-0005	4000
24" Light Fixture	60-18184-0006	4000
Description	Left End Fixture Part No.	Color Temp (K)
72" Light Fixture	60-18185-0102	4000
60" Light Fixture	60-18185-0001	4000
48" Light Fixture	60-18185-0003	4000
36" Light Fixture	60-18185-0004	4000
30" Light Fixture	60-18185-0005	4000
24" Light Fixture	60-18185-0006	4000
Description	Right End Fixture Part No.	Color Temp (K)
72" Light Fixture	60-18185-1102	4000
60" Light Fixture	60-18185-1001	4000
48" Light Fixture	60-18185-1003	4000
36" Light Fixture	60-18185-1004	4000
30" Light Fixture	60-18185-1005	4000
24" Light Fixture	60-18185-1006	4000

Optimax Pro Lighting		
Description	Center Fixture Part No.	Color Temp (K)
72" Light Fixture	60-18184-3102	3500
60" Light Fixture	60-18184-3001	3500
48" Light Fixture	60-18184-3003	3500
Description	Left End Fixture Part No.	Color Temp (K)
72" Light Fixture	60-18185-3002	3500
60" Light Fixture	60-18185-3101	3500
48" Light Fixture	60-18185-3003	3500
Description	Right End Fixture Part No.	Color Temp (K)
72" Light Fixture	60-18185-4002	3500
60" Light Fixture	60-18185-4101	3500
48" Light Fixture	60-18185-4003	3500

3. Optional Wire Assembly

Part Number	Description	Length
60-16404-0005	Wire plug assembly	6 feet
60-16404-0003	Wire plug assembly	6 inches

4. Removing Existing Lighting System

1. Remove the following items:
 - a. Lens
 - b. Fluorescent lamps
 - c. Lamp holder
 - d. Mounting clips
 - e. Ballasts from the existing lighting system
2. For 401D, 1KDR and ELS only:
 - a. Remove the Mullion cover using a flat screwdriver.
 - b. Remove the raceway cover by inserting a flat screwdriver into the seam between the metal raceway and the plastic cover and pry open.

Note: Refer to the case manufacturer's instructions for any questions on removing the fluorescent system and ballast.
3. Seal any open holes on the Mullion using neutral cure silicone sealant (not provided).
4. Make sure you save the two #8 tapping screws used to hold the ballast.

5. Locate, Drill and Mount the LED Fixture to the Mullion



CAUTION – Prior to drilling, make sure that there are no existing components inside the mullion in the areas marked off for the designated holes.

1. Using a ruler, measure the total width of the Mullion at (A) and (B) and mark a vertical line half the total width near the top and bottom of the Mullion.

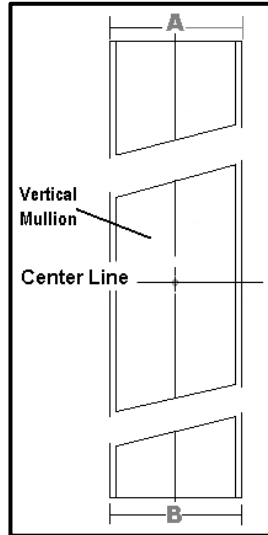

2. Mark a vertical line from the top of the Mullion to the bottom of the Mullion thru the lines measurement in Step 1.
3. Divide the vertical line distance in half and mark as a Center Line.
4. Position the center punch directly over at the intersection of the horizontal line and the vertical line (top, center and bottom) and establish a dimple.
5. Use a power drill and (1/8") 0.125" dia. drill bit, drill (1) hole at the intersection of the vertical center line and the horizontal lines.
6. Referring to orientation of LED fixtures on 99-18901-I002_B (For web Only):
 - a. If the electrical wires are at the top of LED Fixture, go to step e, if the electrical wires are at the bottom of the LED fixture go to step b.
 - b. Place the extrusion notch toward the bottom of the Mullion.

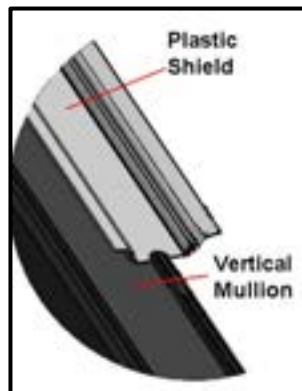

- c. Using a Phillips screw driver, tread a #8 self- tapping screw through the plastic extrusion.

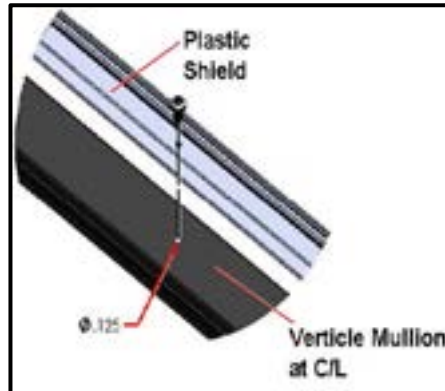

- d. Continue to step 7.
 e. Place the plastic extrusion notch toward the top of the Mullion.

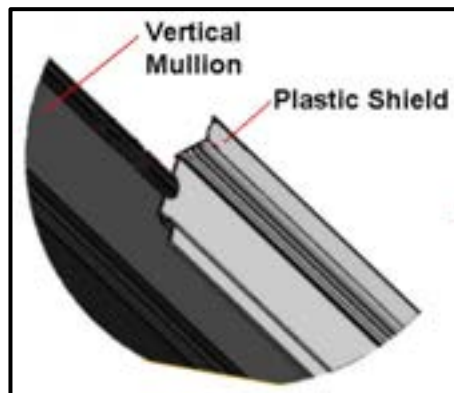

- f. Using a Phillips screw driver, tread #8 self-tapping screw through the plastic extrusion.

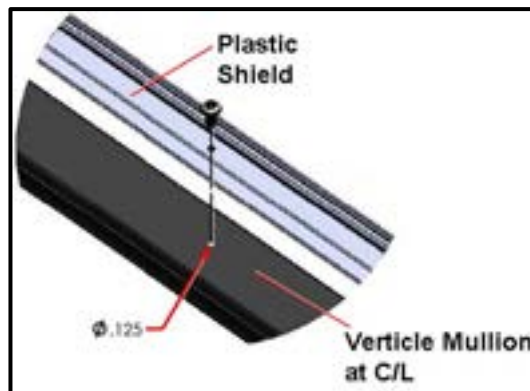

- g. Continue to step 7.

7. Position the center punch directly over the vertical line and within the plastic extrusion notched cutout, establish a dimple.



8. Use a power drill and (3/8") 0.375" dia. drill bit, drill (1) hole.
9. Snap the LED fixture into the plastic extrusion. Refer to "Parts List".
10. Thread the LED wires through the 3/8" hole.
11. Align the LED fixture with the vertical lines made in Step 2 and using a center punch, establish two dimples, one at the top and one at the bottom of the end clips.
12. Use a power drill and (1/8") 0.125" dia. drill bit, drill (2) holes through the LED top and bottom mounting brackets through the plastic extrusion.
13. Using a Phillips screw driver, thread #8 self-tapping screw through the plastic extrusion.

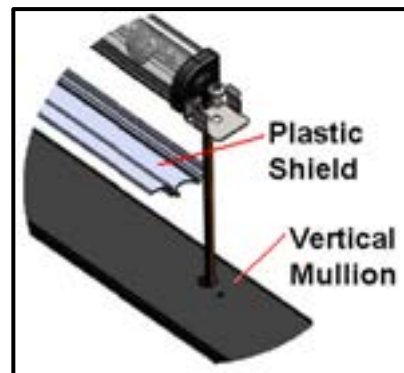

14. Snap J-Box cover on the wire-end of end clip.

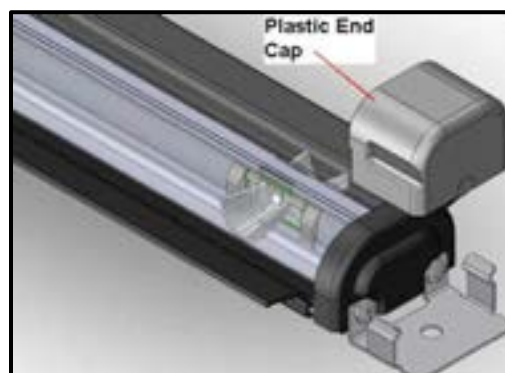

6. Mounting the LED Power Supplies

6.1. High Power and Low Power Driver Connections

1. Install the LED power supply in the same location where the ballast was fitted or in the general location for ease of wire connection.
2. Mount the LED power supply using two #8 tapping screws saved when the ballast was removed.

Note: Installer may have to drill two holes in the raceway to accommodate the LED power supply.

Note: The LED power supply case is grounded. Attach the LED power supply to a ground point in the refrigerated case either directly with a screw or by using the green wire to attach to a remote point.

3. Connect LED Light fixture wire connectors to the LED power supply using the plug assembly provided. Refer to "Optional Wire Assembly".

Note: The OptiMax Pro fixtures are polarity sensitive. Pay close attention when wiring the fixture's red (+) wires to the red wires of the driver, and the black (-) wires of the driver.

4. Connect the primary LED power supply input 3-position plug (blue, green and white/blue wires) to the harness electrical 3-position plug (blue/white and white/blue wires).
5. Turn the power on and verify that the LED fixture(s) are working.
6. Reinstall the raceway cover(s).

7. Wiring Diagrams and Orientation

7.1. Typical Configuration – One Door (07-18678-0001)

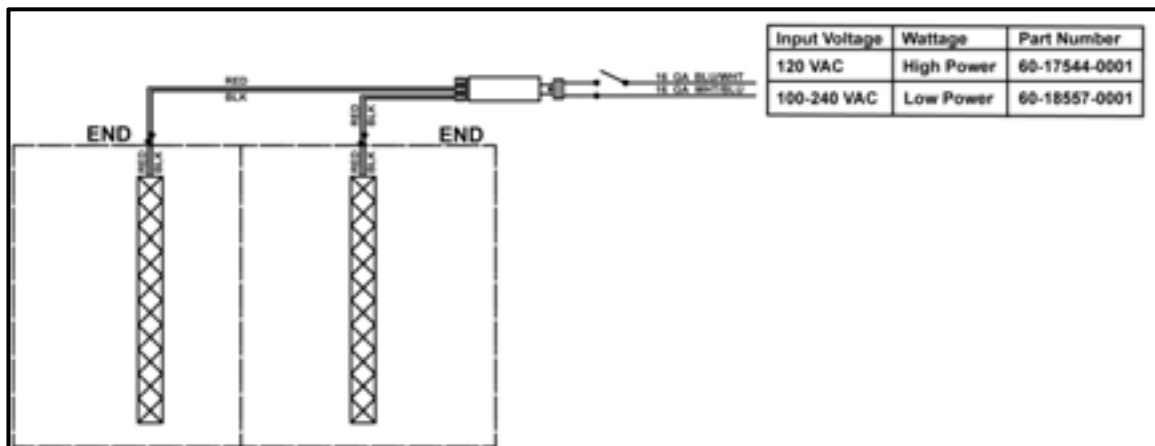

7.2. Typical Configuration – Two Door (07-18678-0002)

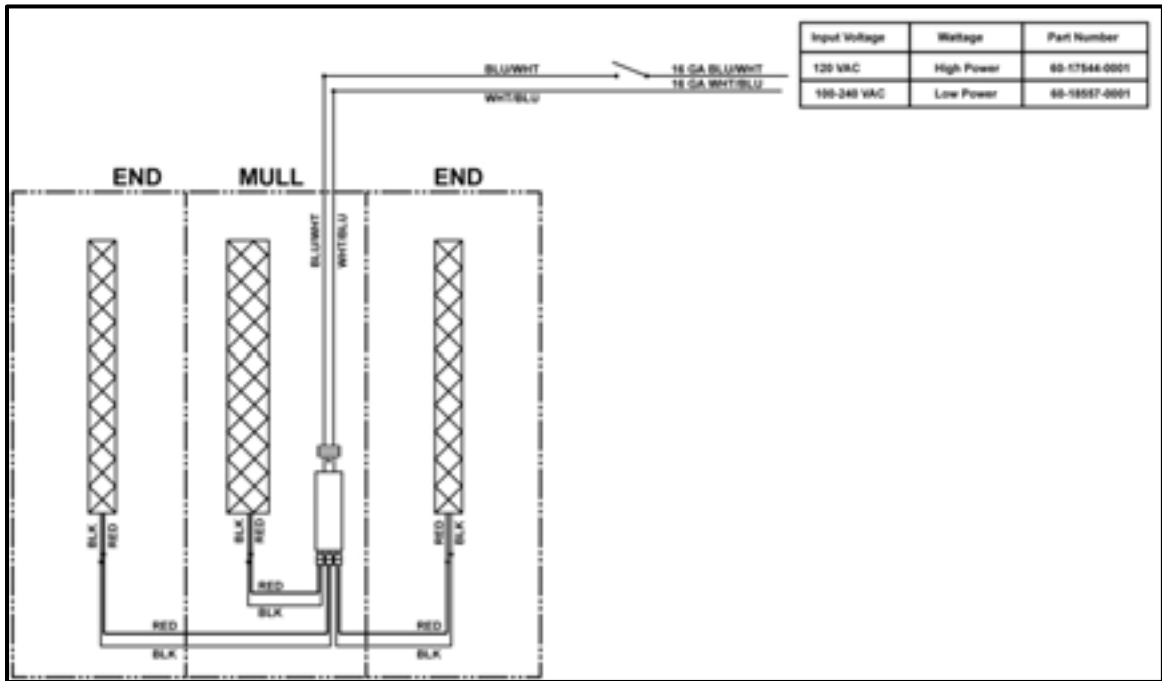

7.3. Typical Configuration – Three Door (07-18678-0003)

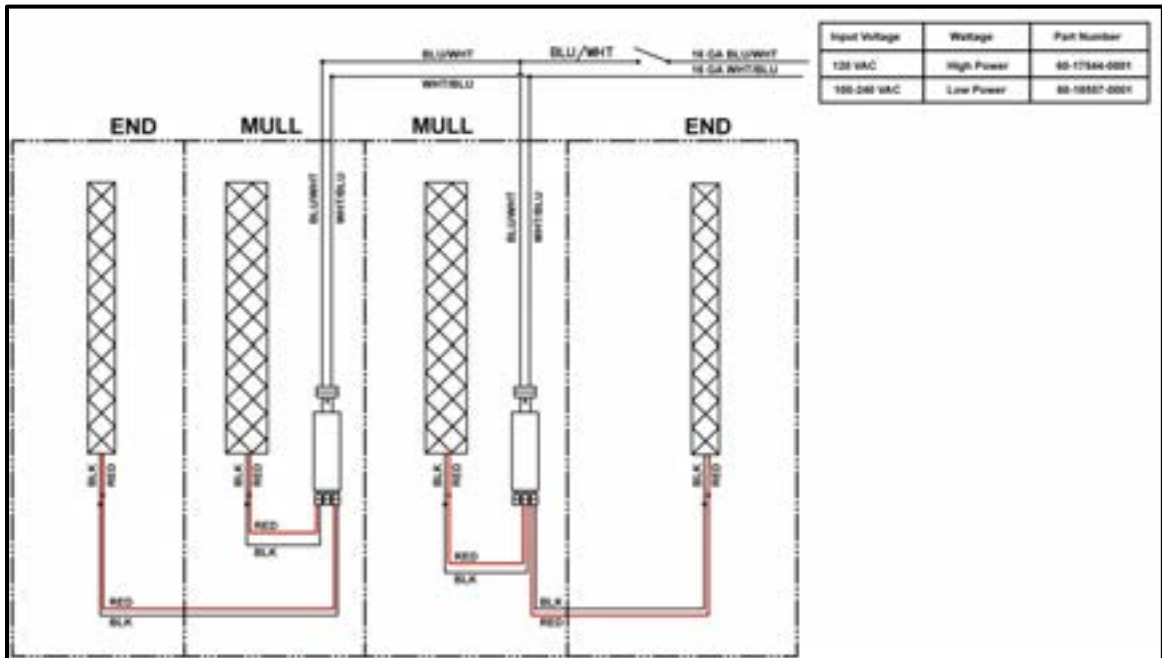

7.4. Typical Configuration – Four Door (07-18678-0004)

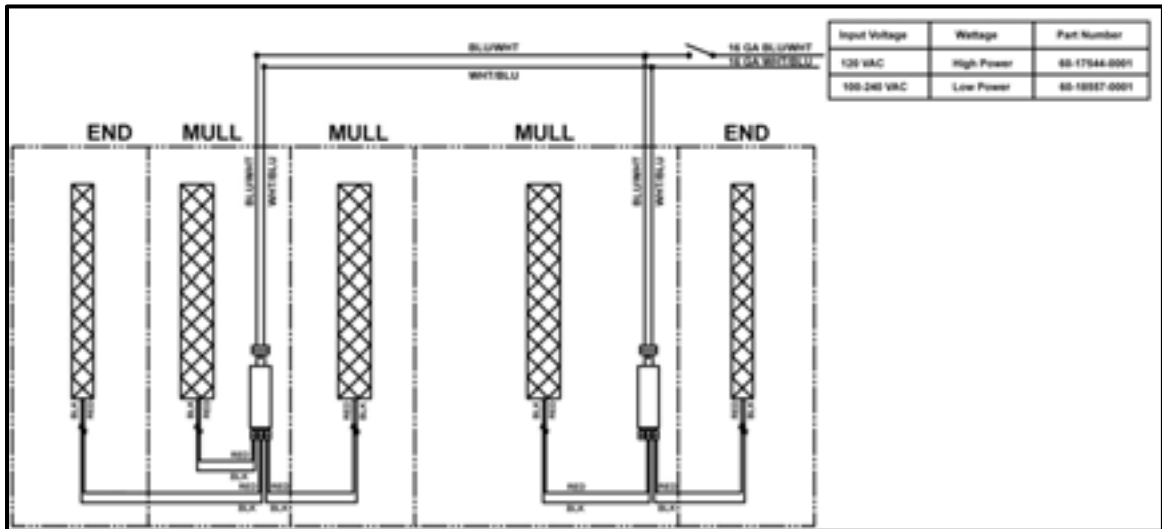

7.5. Typical Configuration – Five Door (07-18678-0005)

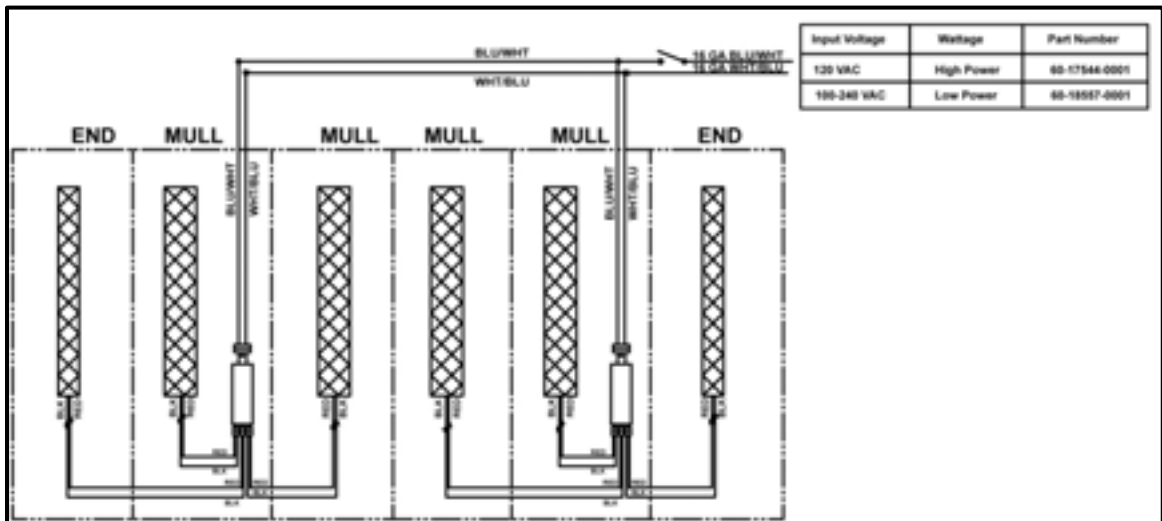

7.6. Typical Configuration – Six Door (07-18678-0006)

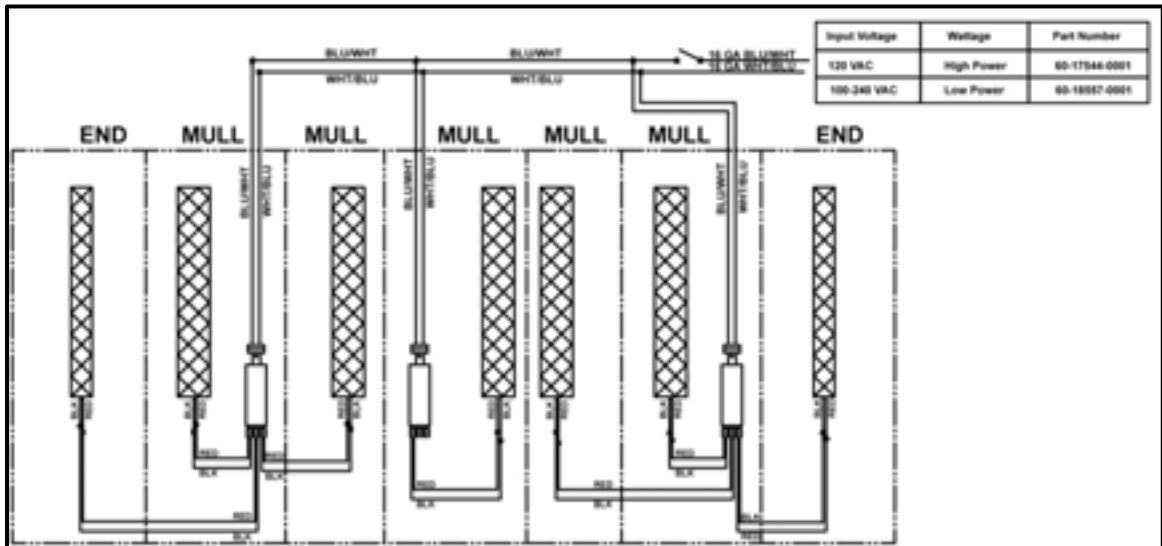

7.7. Typical Configuration – One Door (07-18679-0001)

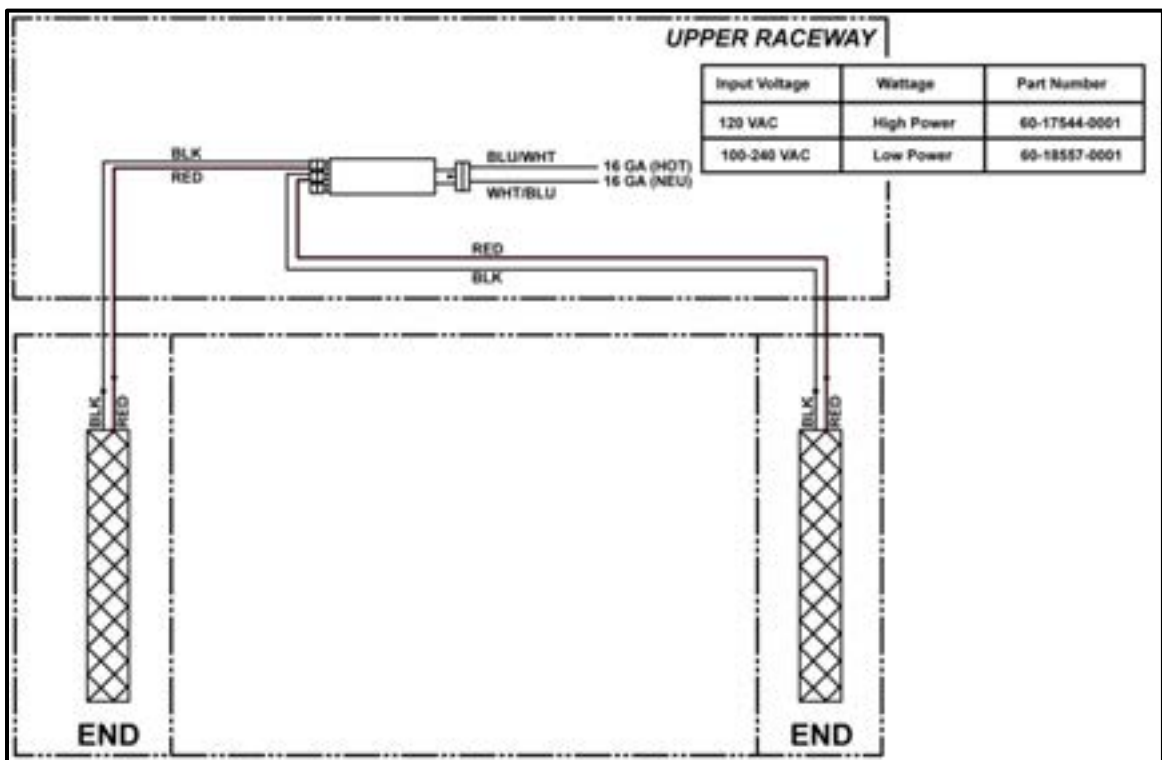

7.8. Typical Configuration – Two Door (07-18679-0002)

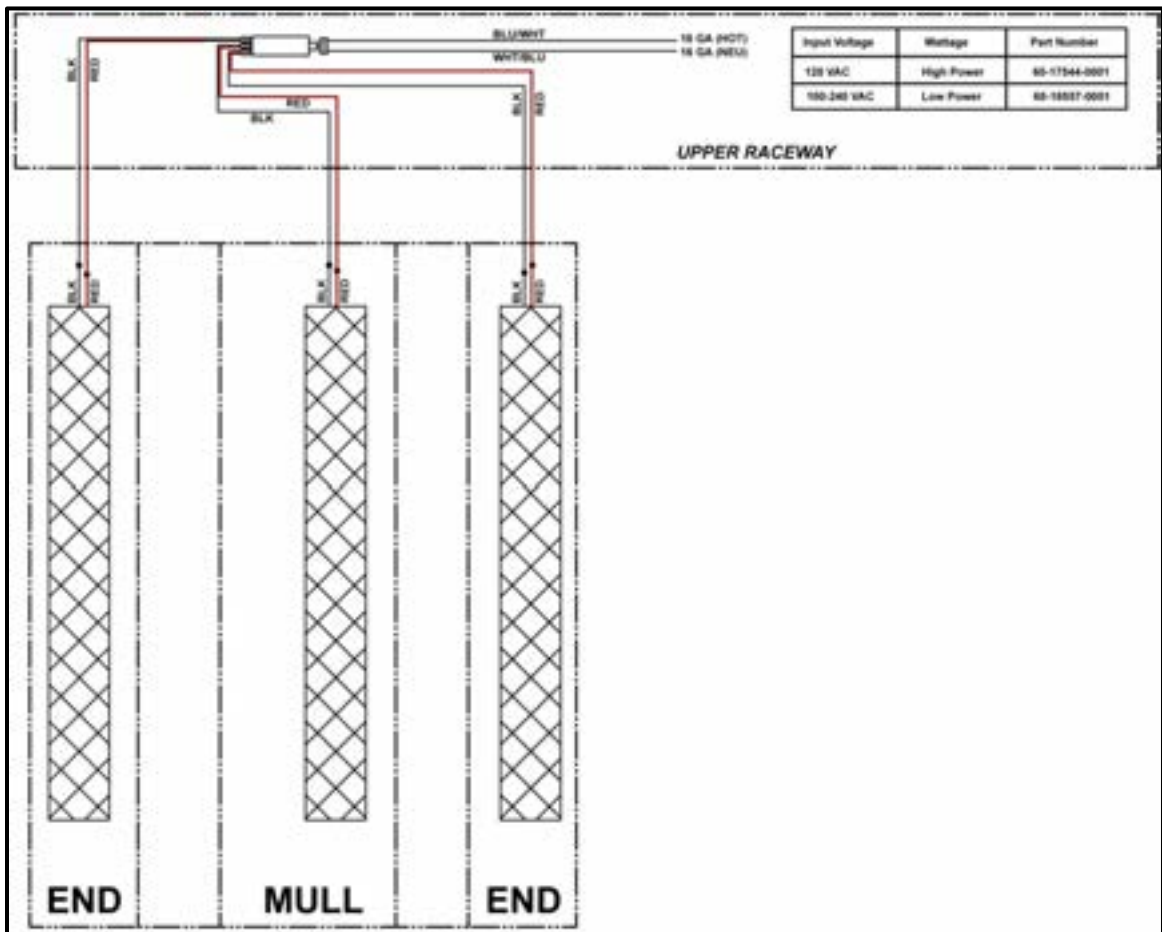

7.9. Typical Configuration – Three Door (07-18679-0003)

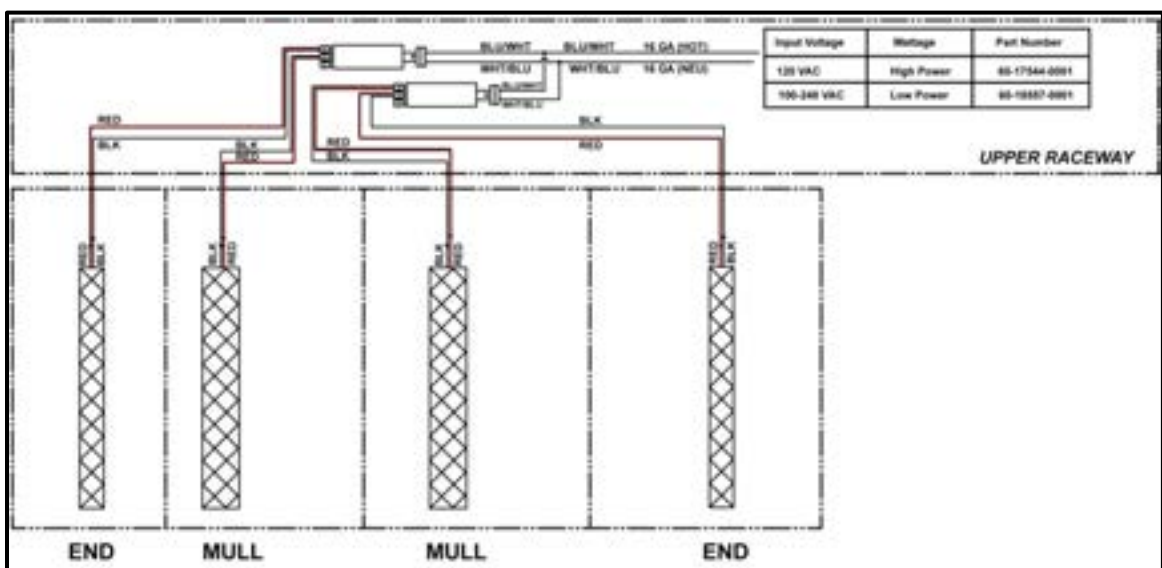

7.10. Typical Configuration – Four Door (07-18679-0004)

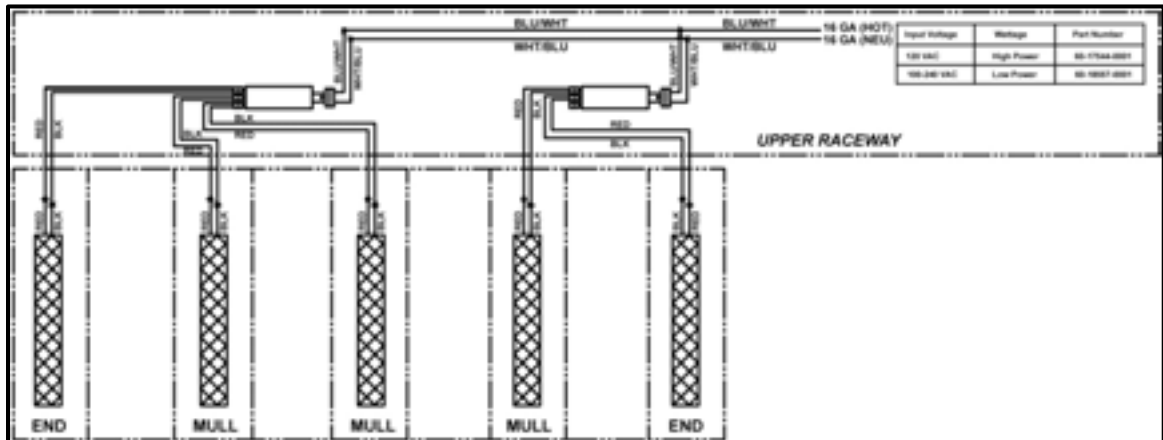

7.11. Typical Configuration – Five Door (07-18679-0005)

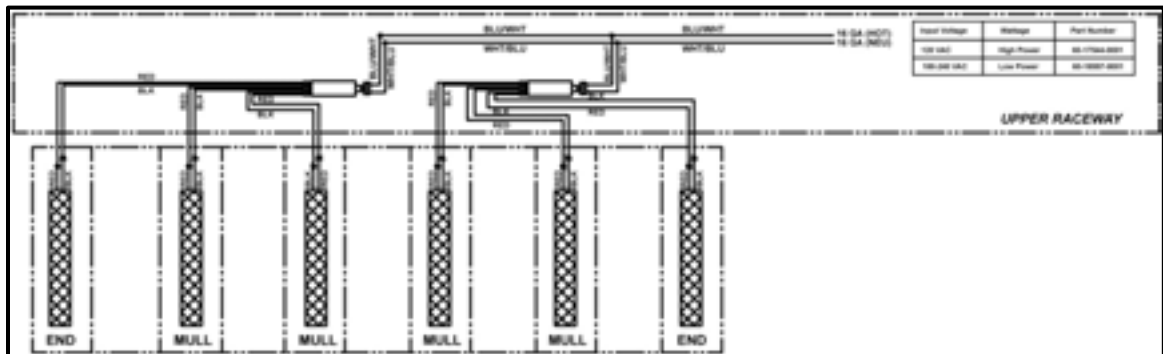

7.12. Typical Configuration – Six Door (07-18679-0006)

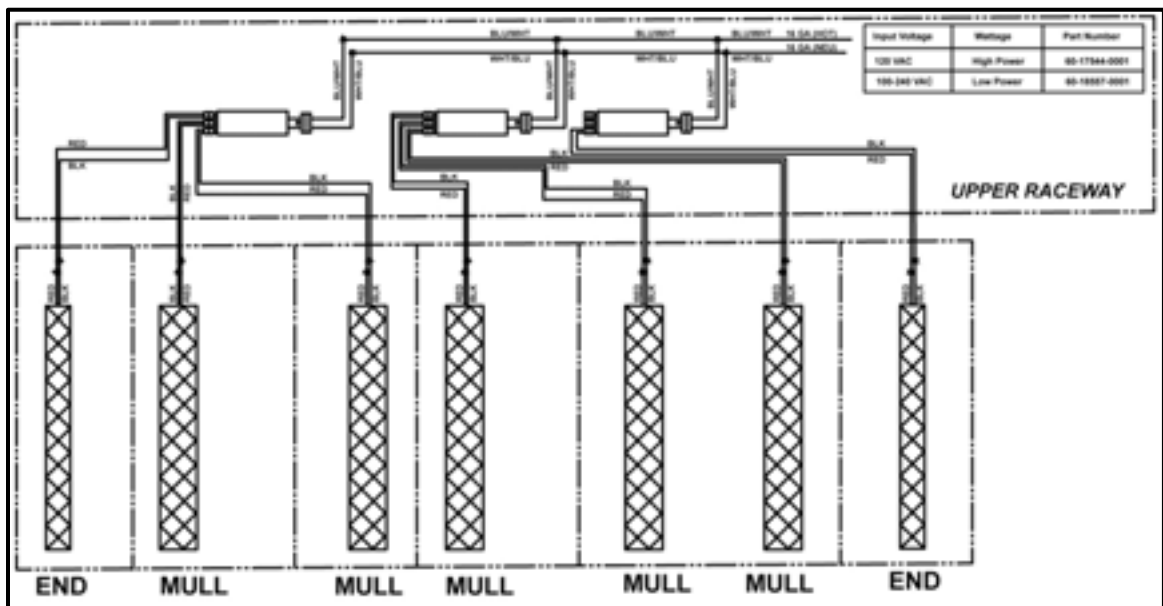

8. Revision History Page

REV	ORIGINATOR	DESCRIPTION OF CHANGE	EFFECTIVE DATE
A	SWatstein	Initial Release	03/22/2011
B	SWatstein	Update page 5, 6, 7	04/21/2011
C	S. Fisher	Reformat from PDF to Word	04/16/2013